

一、配件清单



A.1PCS



B.1PCS

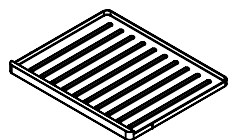

C.1PCS

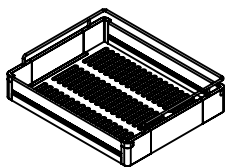

D.1PCS

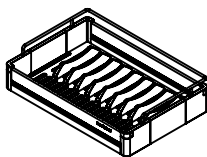

E.1PCS



F.4PCS

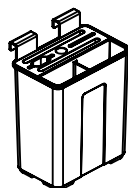

G 2PCS

二、产品尺寸

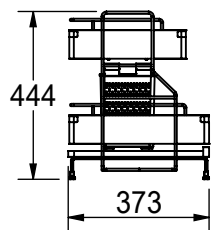
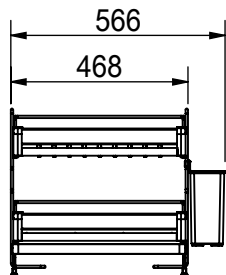

台式沥水架安装说明书

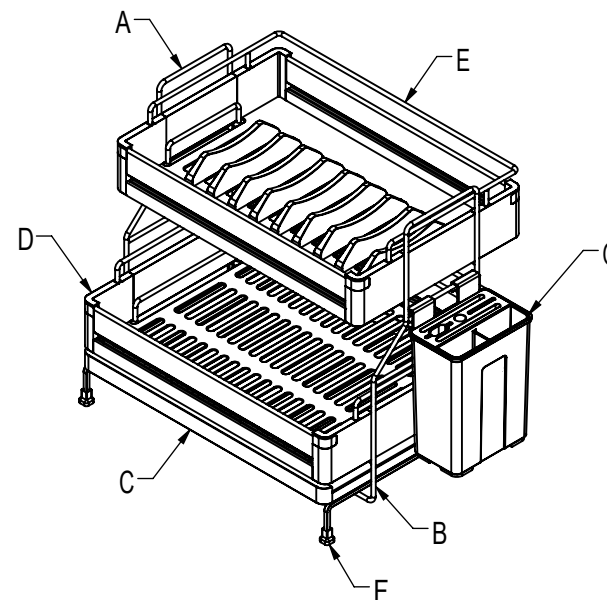

产品型号：A0990C1&2A